

# Data Sheet



Article number: 23110111015

Description: E+G Column level indicator  
HCK.127-GL-M12, for glycol-based solutions

## Measures

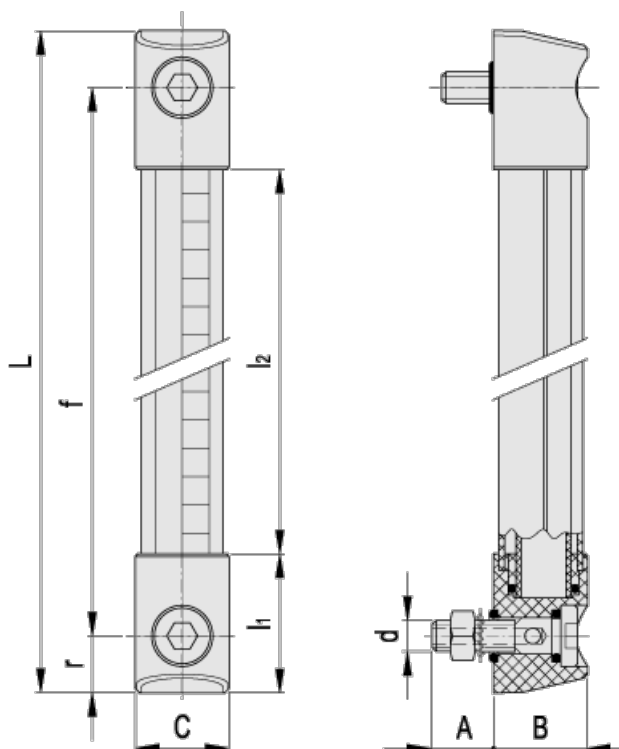

A = 20

r = 18.5

B = 33

C = 33

d = M12

f = 127

L = 164

l1 = 46.5

l2 = 71